

Situation with battery clips

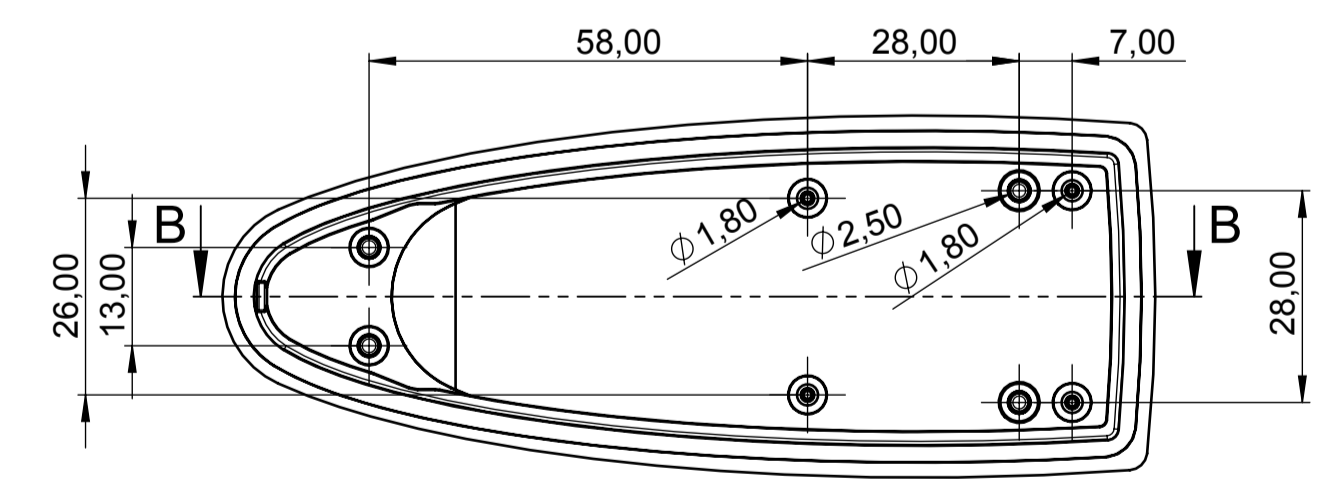
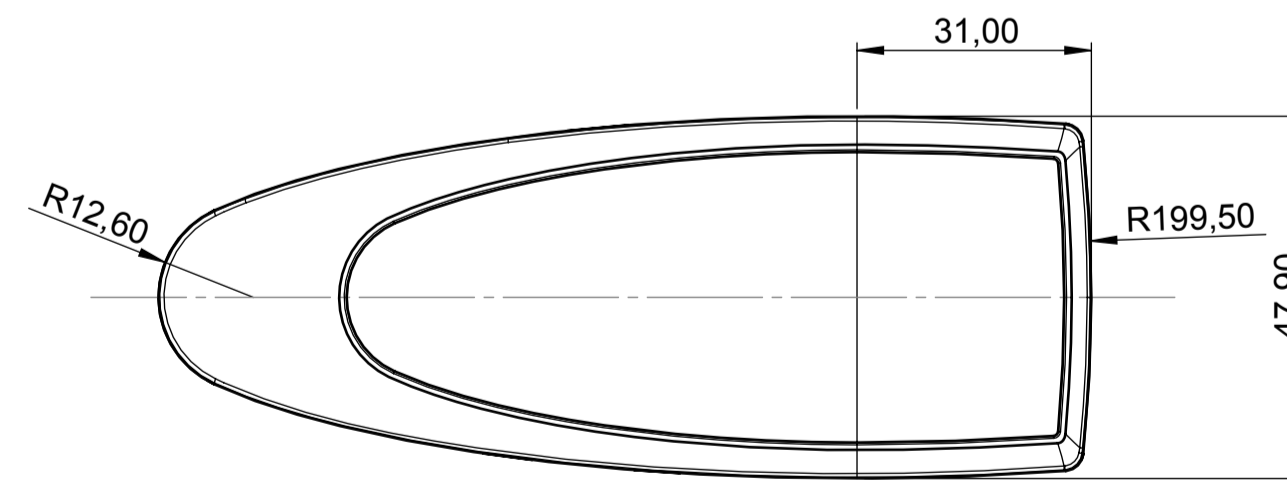
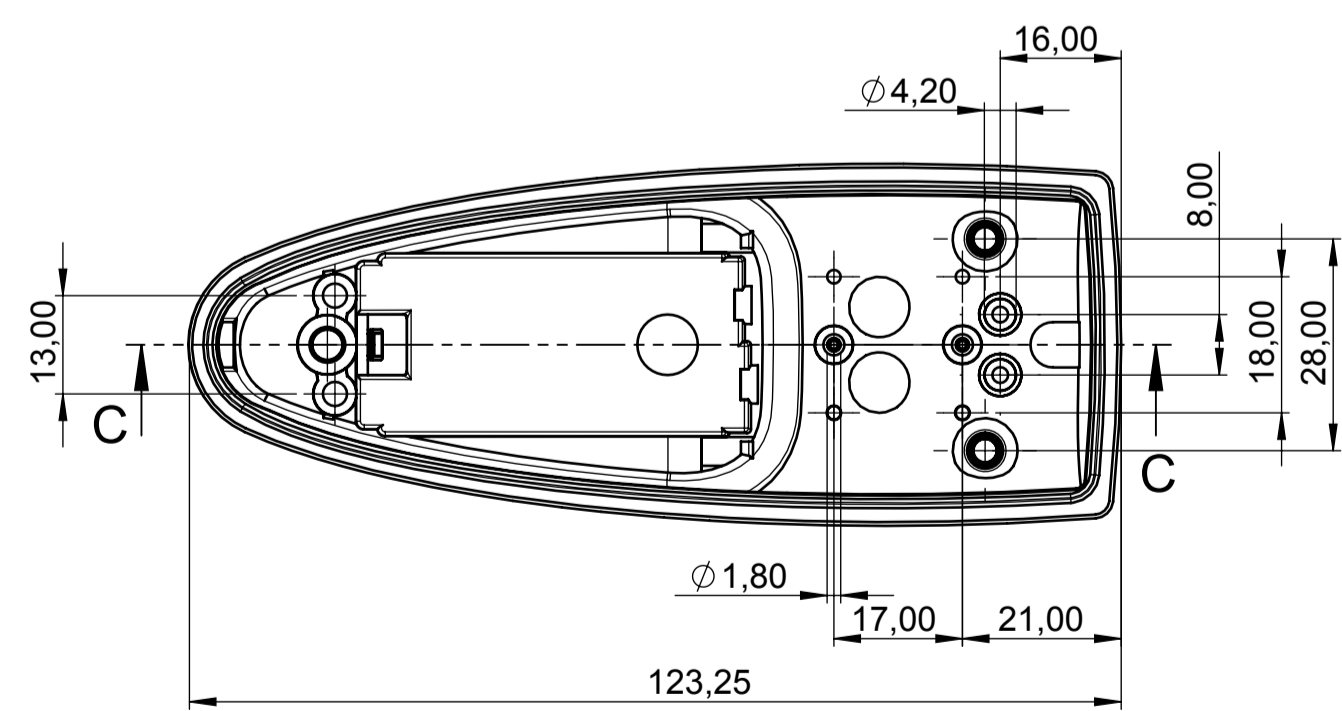
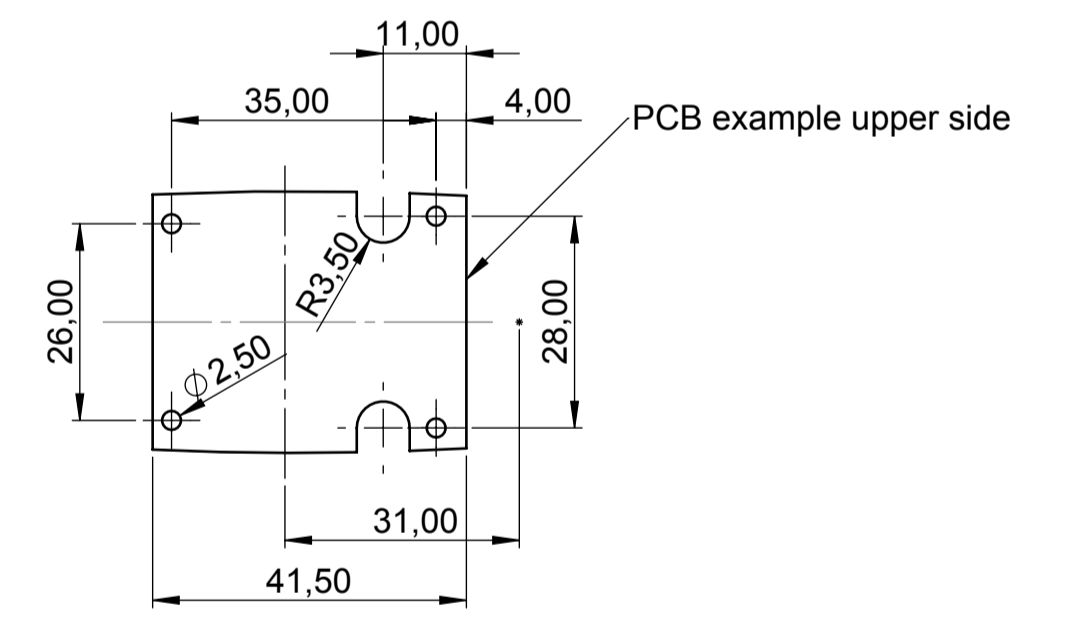
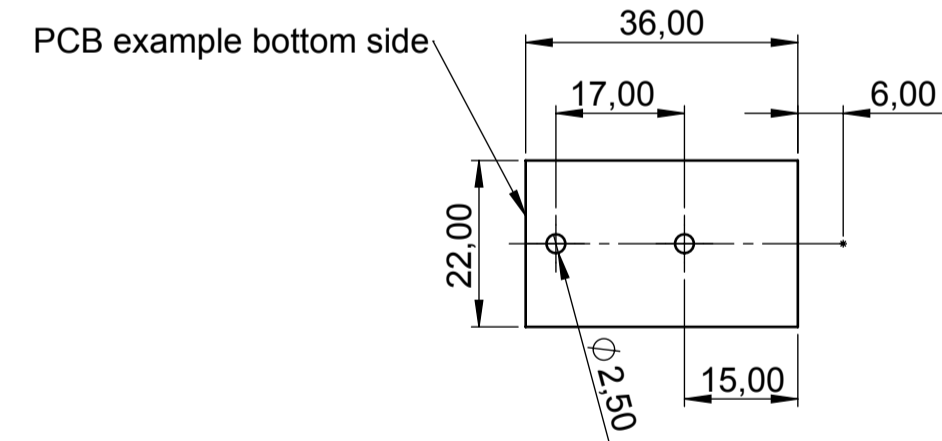
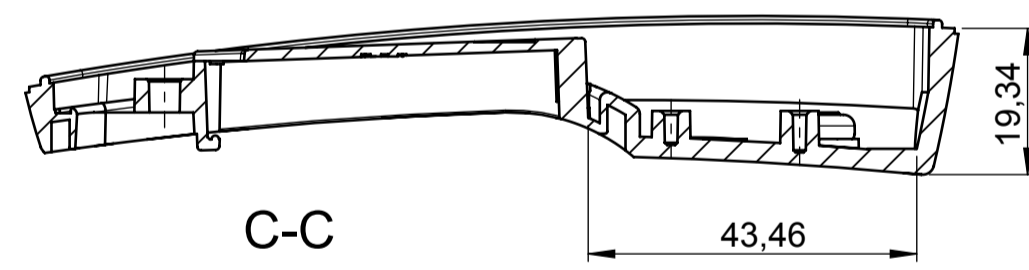
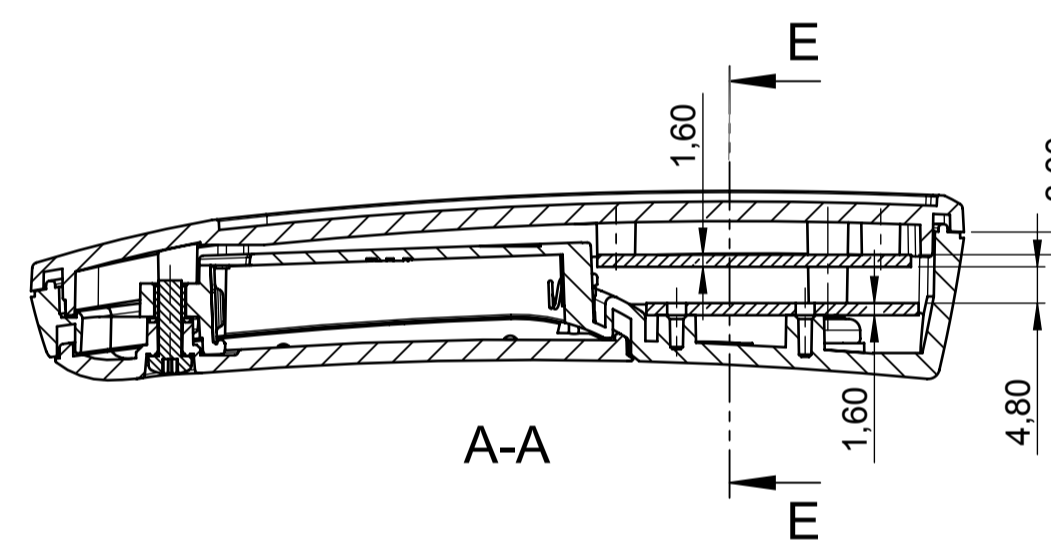
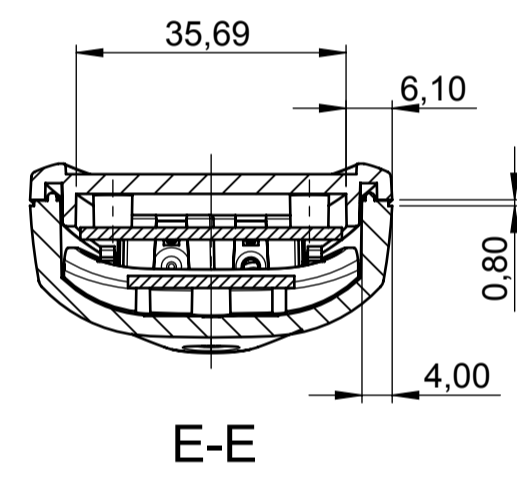
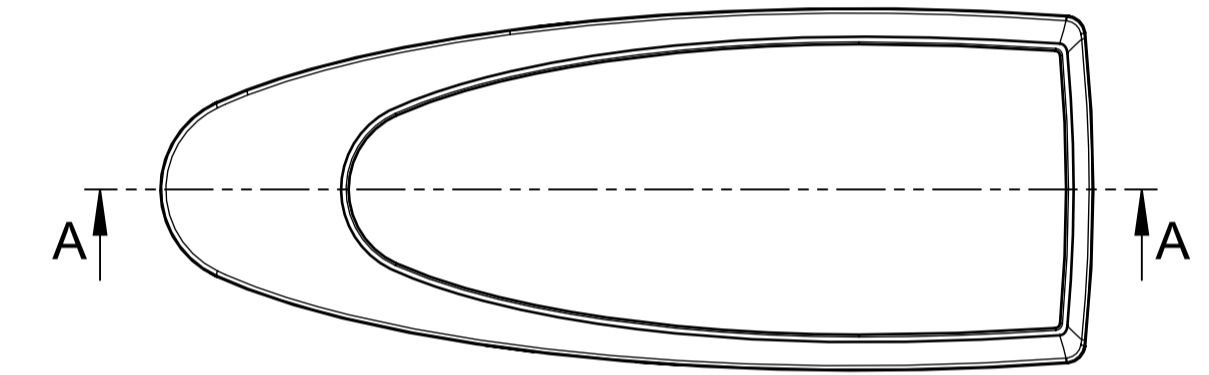
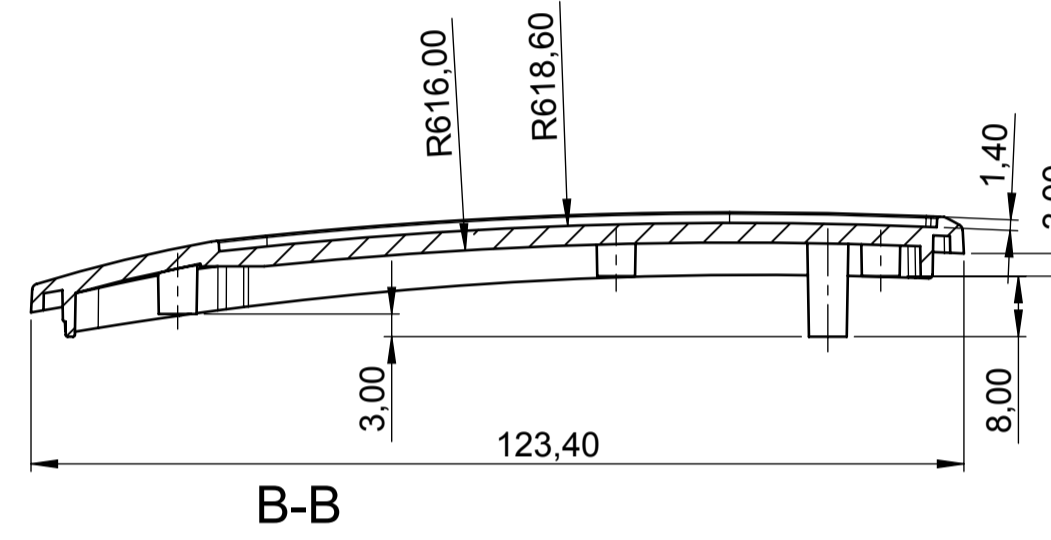
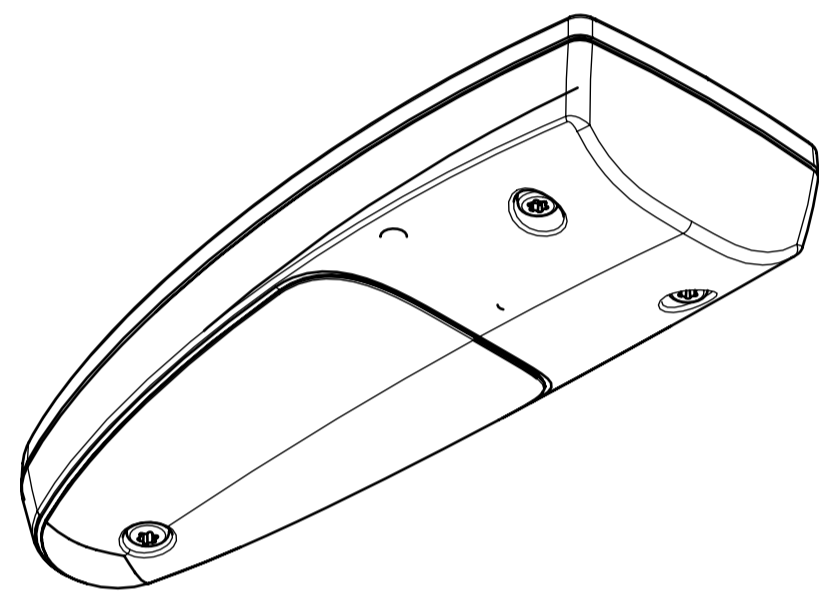

Informationskopie wird nicht aktualisiert Copy for Information will not be updated	Erst. am: 25.09.2017 Erst. von: D. Hasselbach Freig. am: Freig. von: Revision: 01	Toleranzen: DIN 16742 Tg 6 Volumen: Zeichnungsart: KUNDE	Status: ENTWICKLUNG Zeichnungsart: KUNDE DIN 6 Teil 2
	This document contains proprietary information of OKW Gehäusesysteme GmbH and is rendered subject to the conditions that the information be retained in confidence and not be reproduced or copied and not be used or incorporated in any product.		
	OKW GEHÄUSE SYSTEME		
	STYLE-CASE S Drawing for customers information B280210* M 1:1 Für dieses Dokument behalten wir uns alle Urheberrechte vor. Es darf auch auszugsweise weder vervielfältigt noch Dritten in irgendeiner Form zugänglich gemacht werden.		