

Platine Oberteil
PCB top

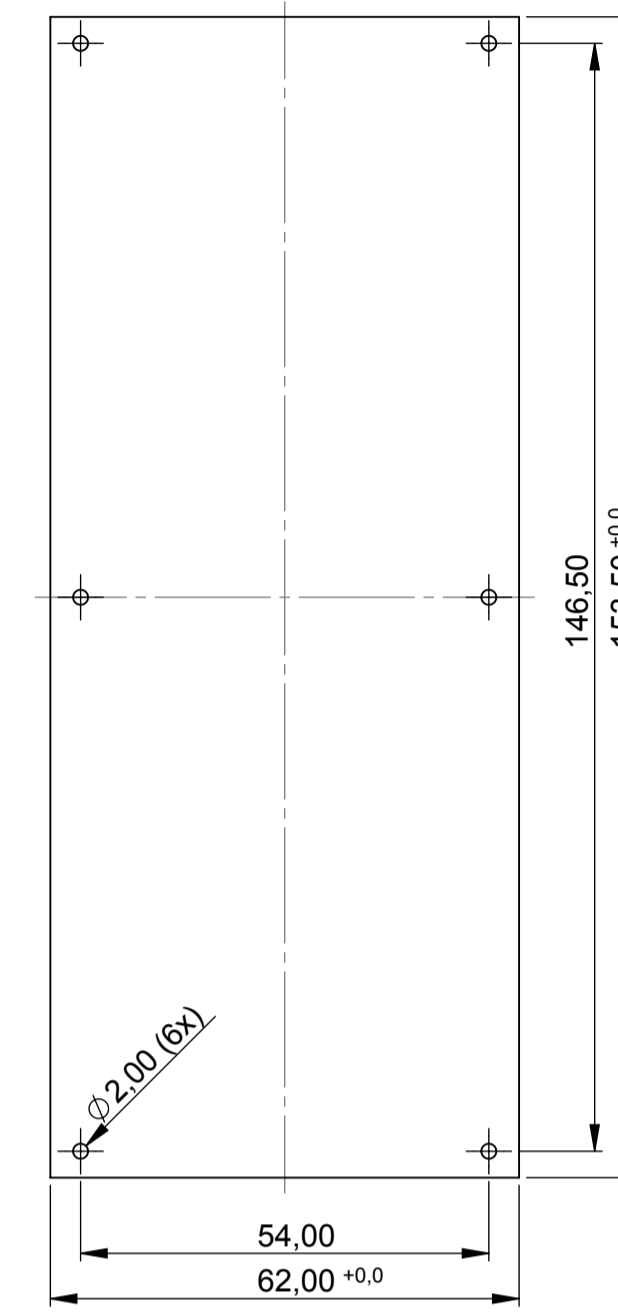

Platine quer
PCB square

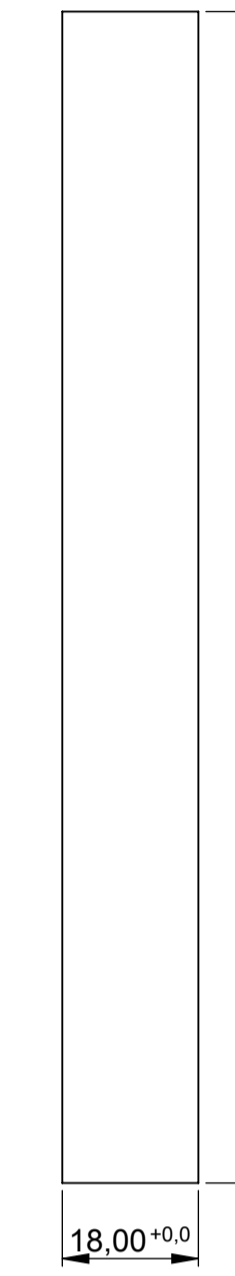

Folientastatur
Membrane keyboard

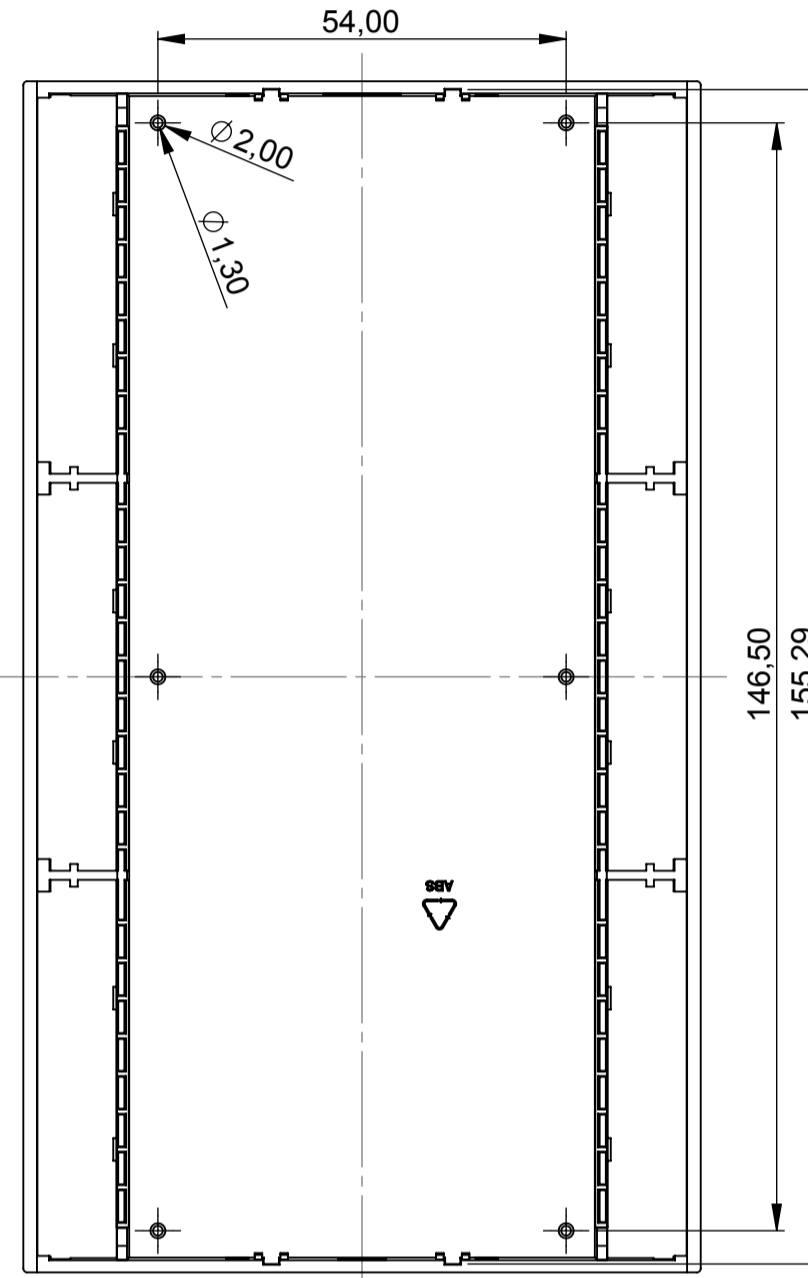
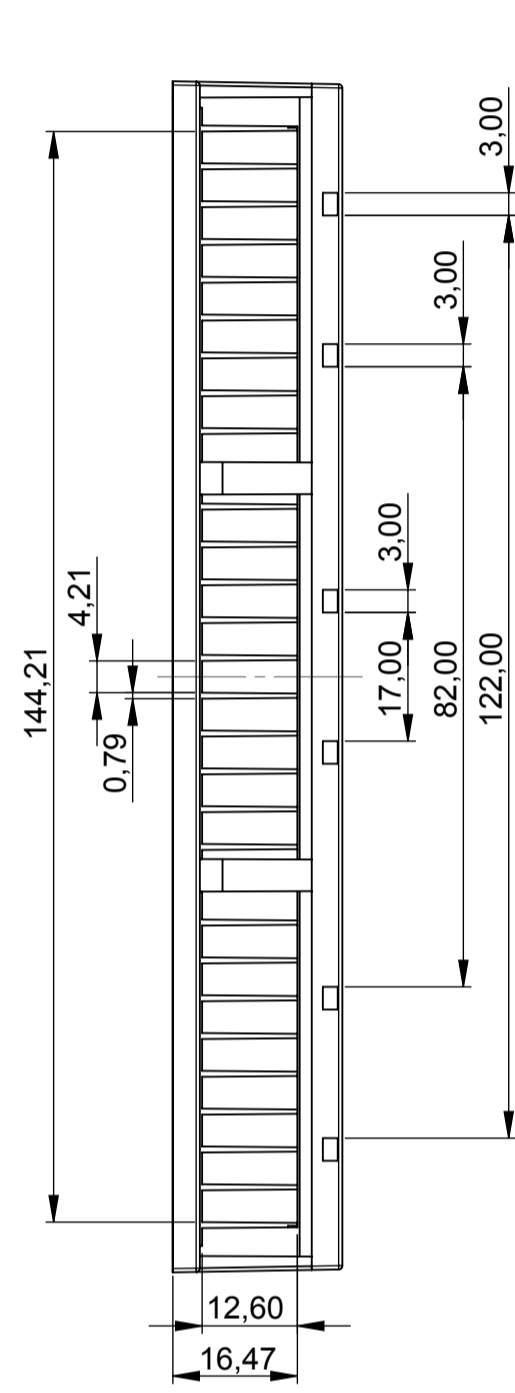
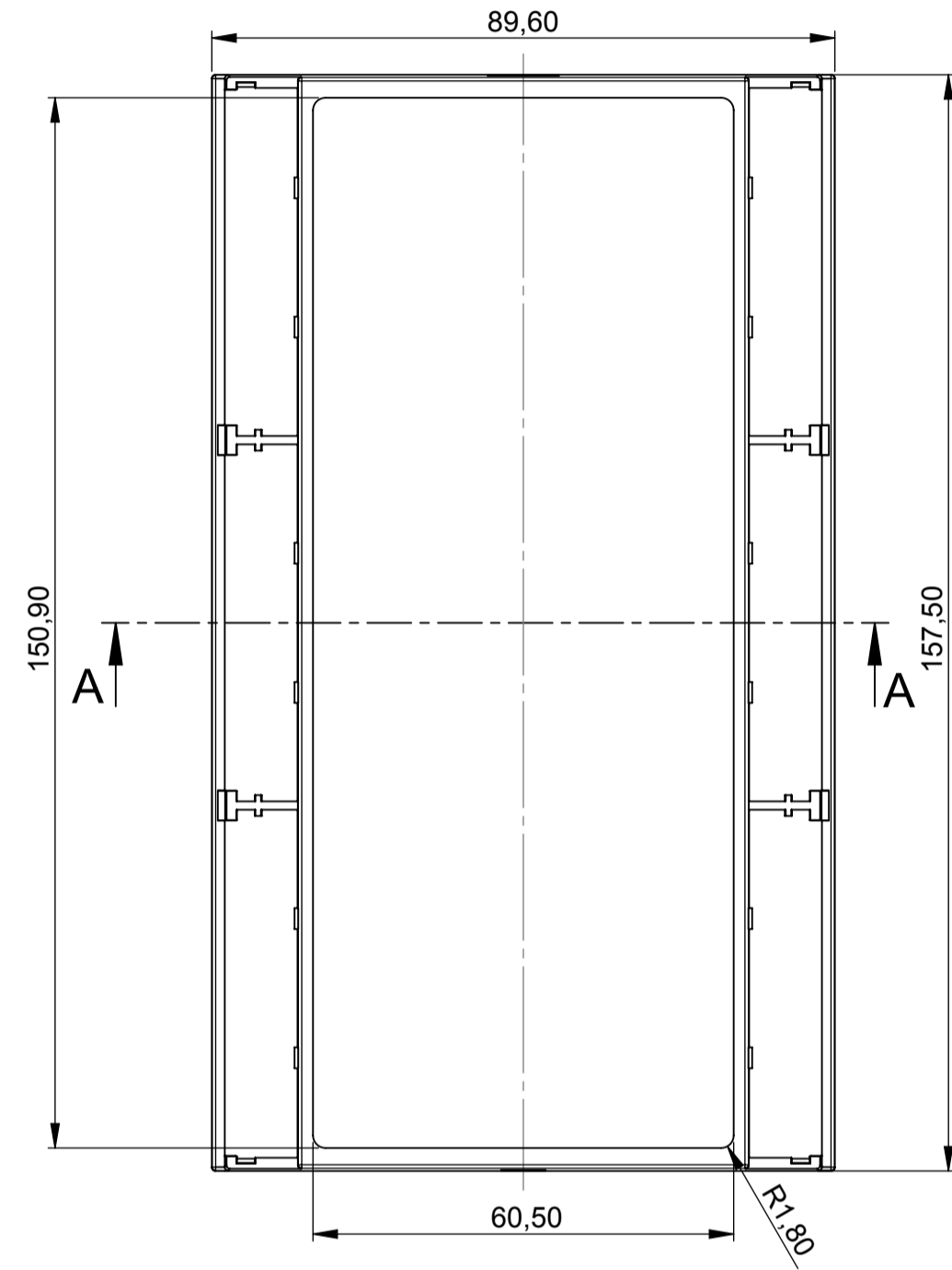
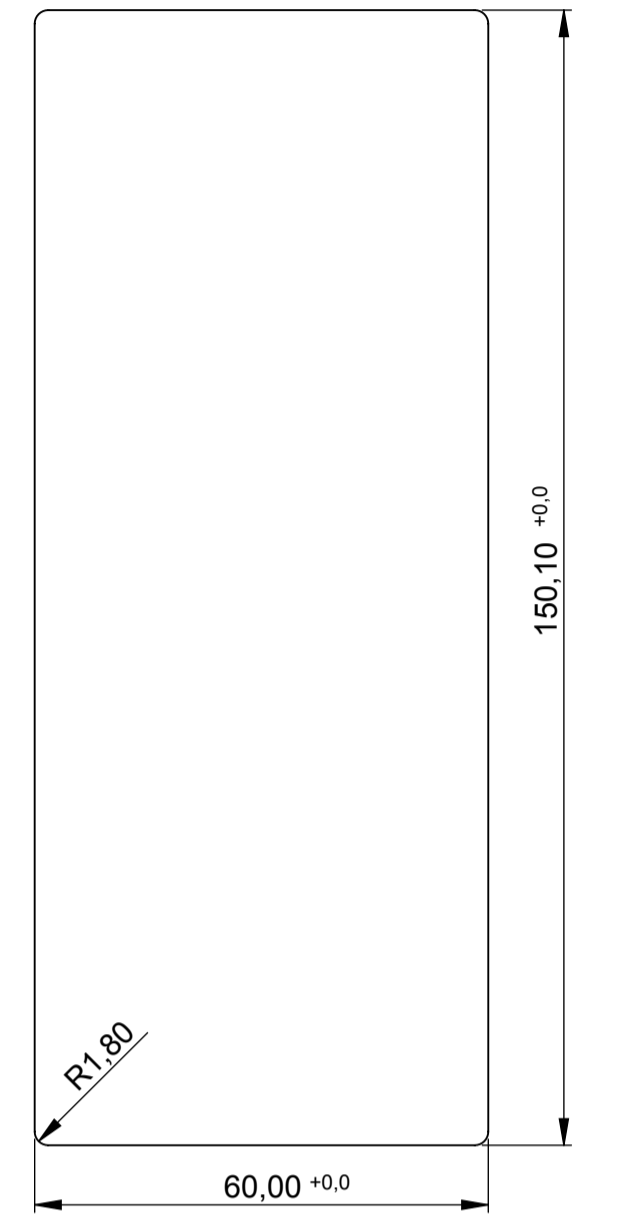

Leiterplatte für das Unterteil
Raster 5.0 PCB for base
block 5.0

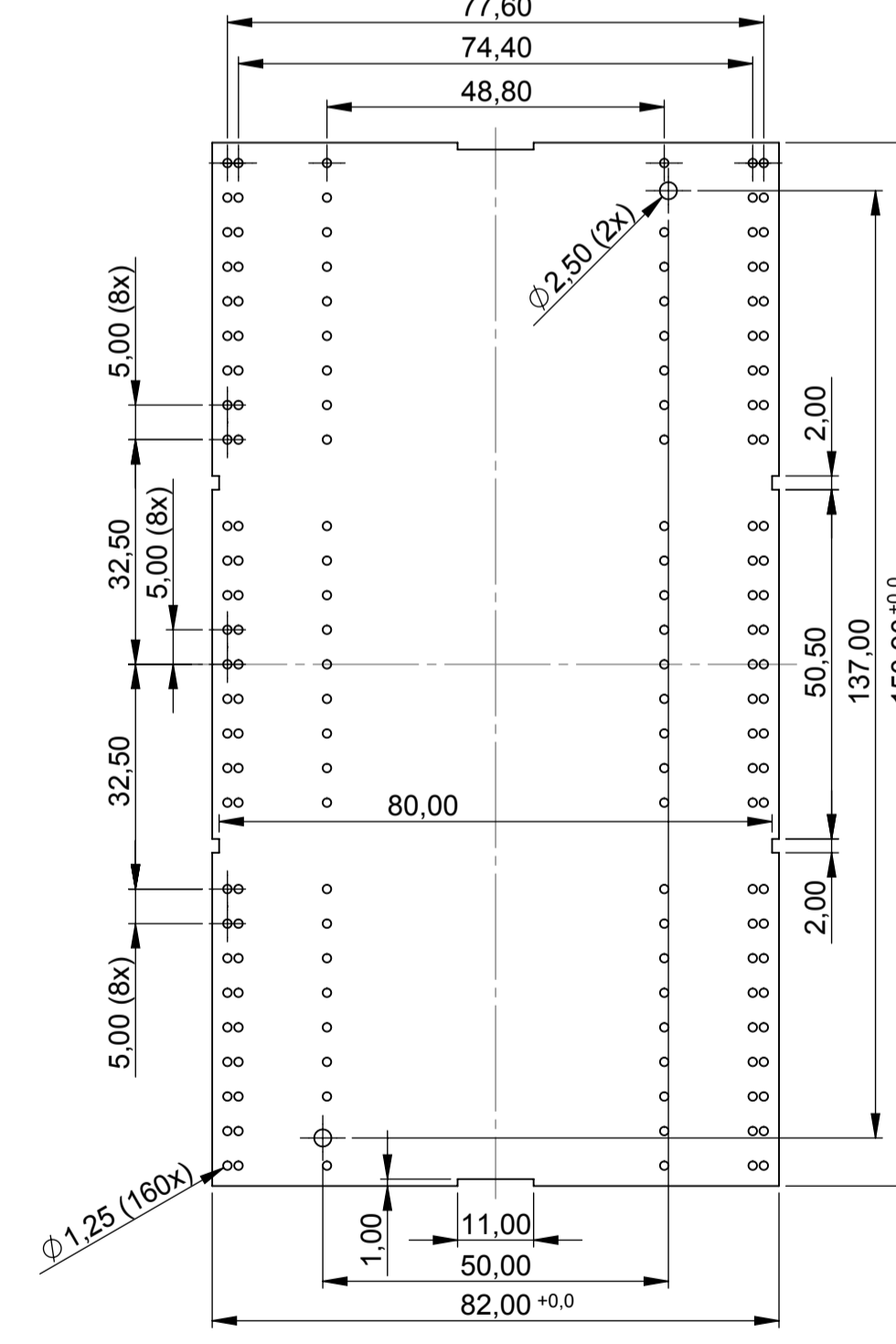

Leiterplatte für das Unterteil
Raster 5.08 PCB for base
block 5.08

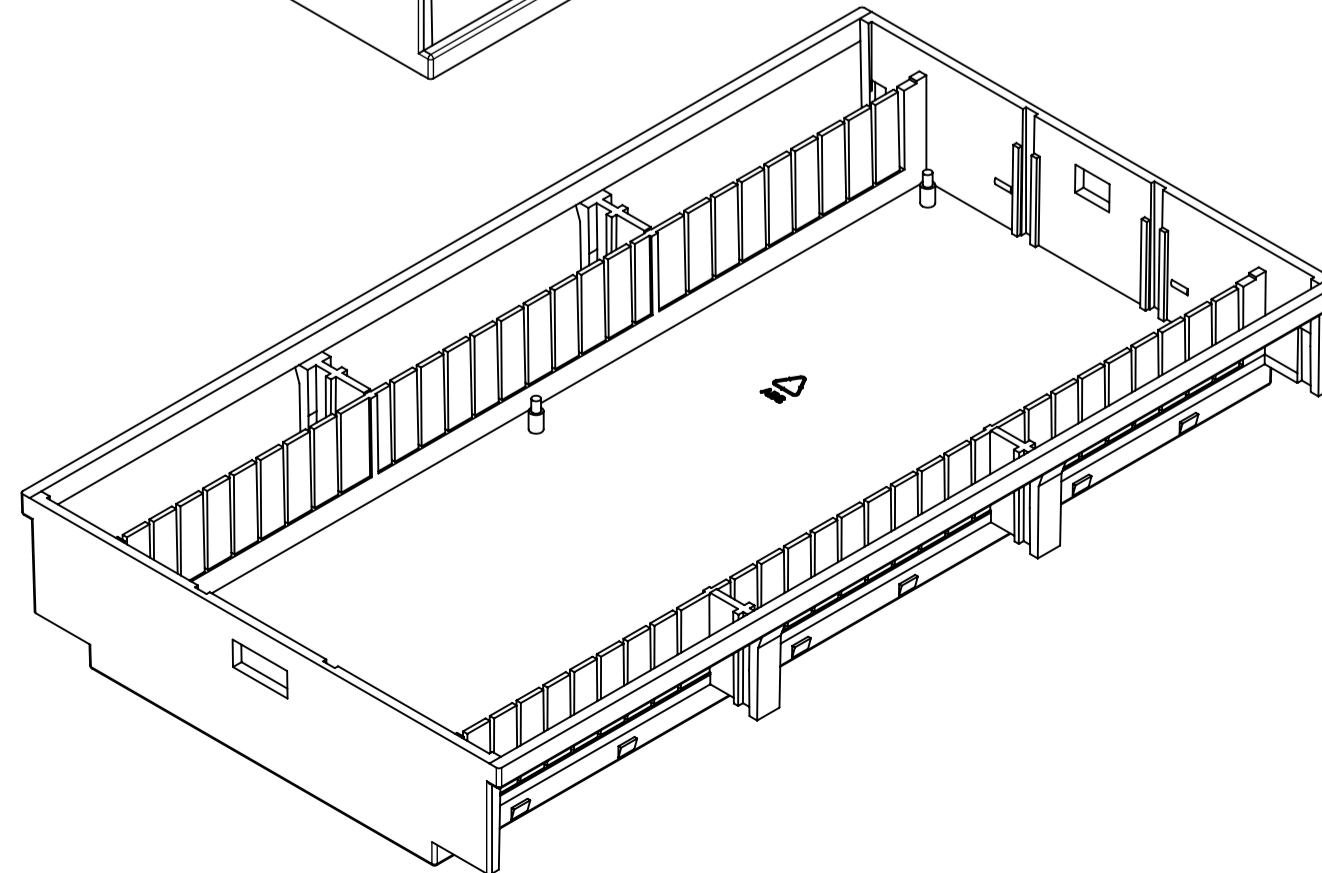
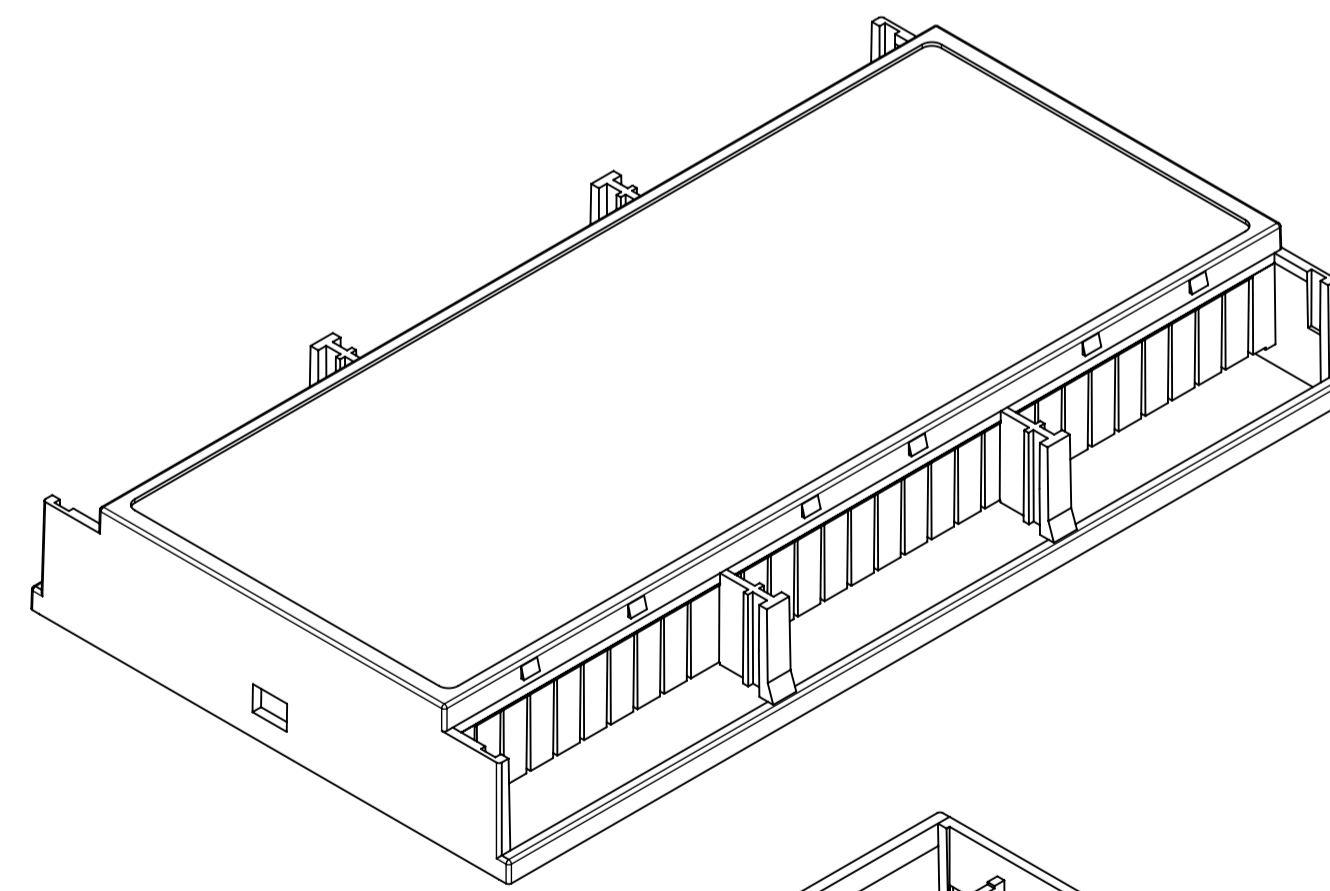
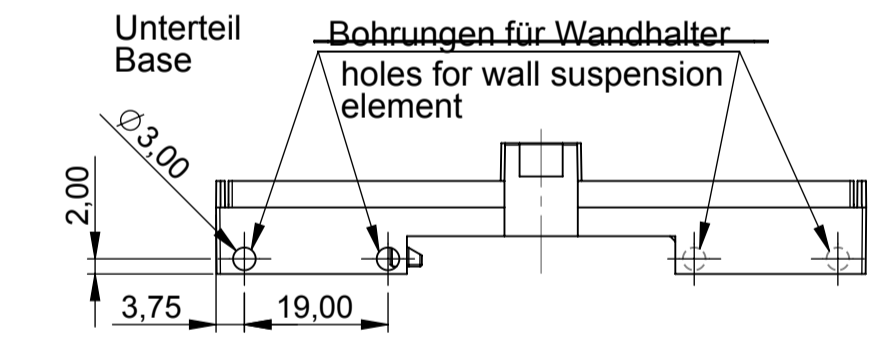
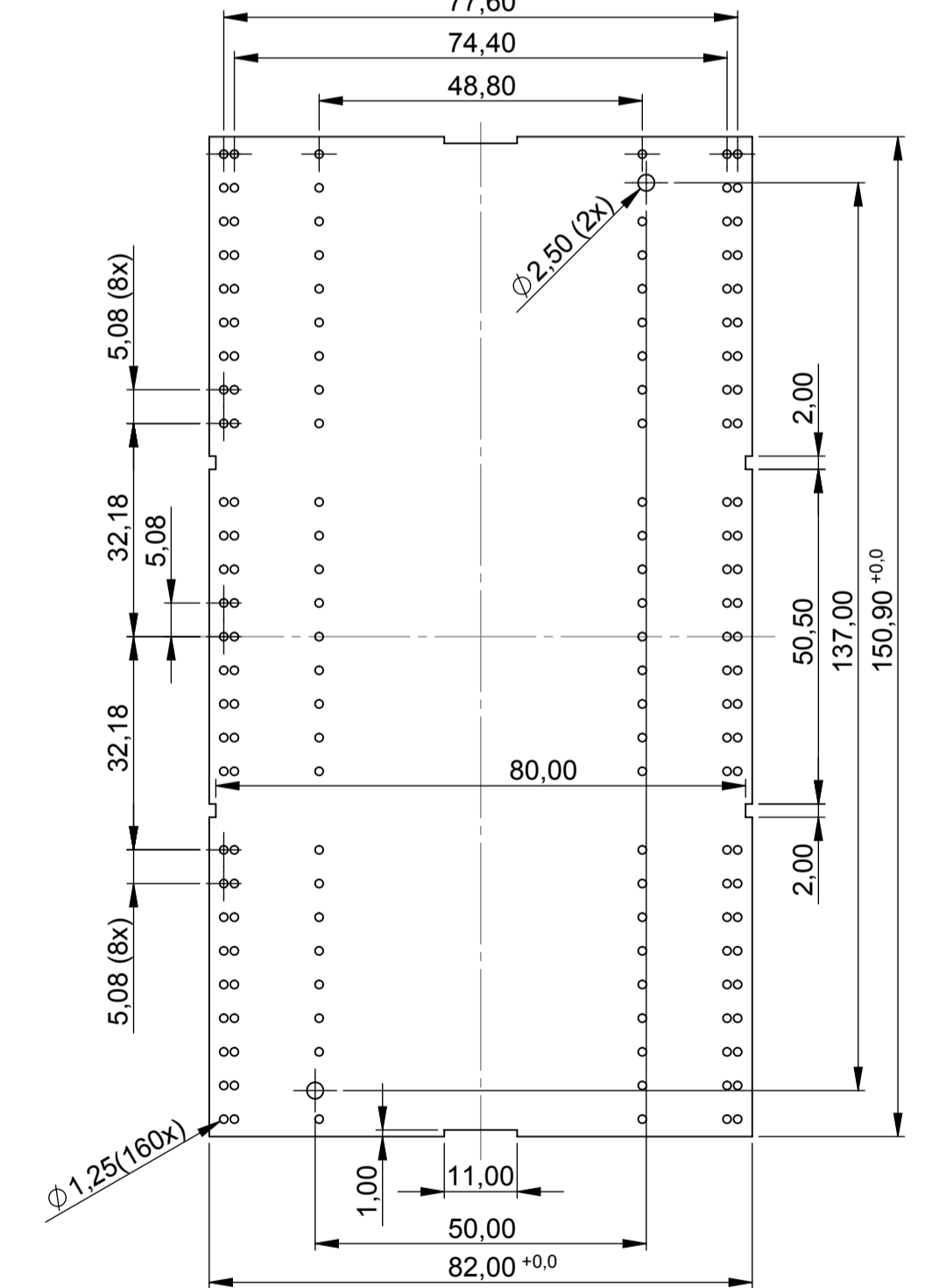

Informationskopie Copy for Information will not be updated	Erst. am: 05.02.2014 Erst. von: D. Hasselbach	Toleranzen: DIN 16901 T130	Status: ENTWICKLUNG	
	Freig. am: Freig. von:	Volumen: KUNDE	Zeichnungsart: KUNDE	
	Revision: 01	This document contains proprietary information of OKW Gehäusesysteme GmbH and is rendered subject to the conditions that the information be retained in confidence and not be reproduced or copied and not be used or incorporated in any product.		
	Technische Änderungen vorbehalten. Irrtümer oder Druckfehler begründen keinen Anspruch auf Schadensersatz. Wichtige Einbaumaße bitte direkt mit dem aktuellen Produkt ablesen. Subject to technical modification without prior notice. Typographical and other errors do not justify any claim for damages. All dimensions should be verified using an actual moulded part. Sous réserve de modifications techniques. Toute erreur ou faute d'impression ne justifie aucune demande d'indemnisation. Nous prions les clients de vérifier les dimensions des composants avec les boîtiers avant la montage.			
RAILTEC B 9 Module Vers. low profile B6505229		M 1:1 Für dieses Dokument behalten wir uns alle Urheberrechte vor. Es darf auch auszugsweise weder ververvielfältigt noch Dritten in irgendeiner Form zugänglich gemacht werden.		Dateiname: 00016107